

Varenummer: 204360M863D1S
 Beskrivelse: E+G Justerfod
 GN 43-60-M8-63-D1-S
 Note: S Uden møtrik, udvendig sekskant i bunden

Mål

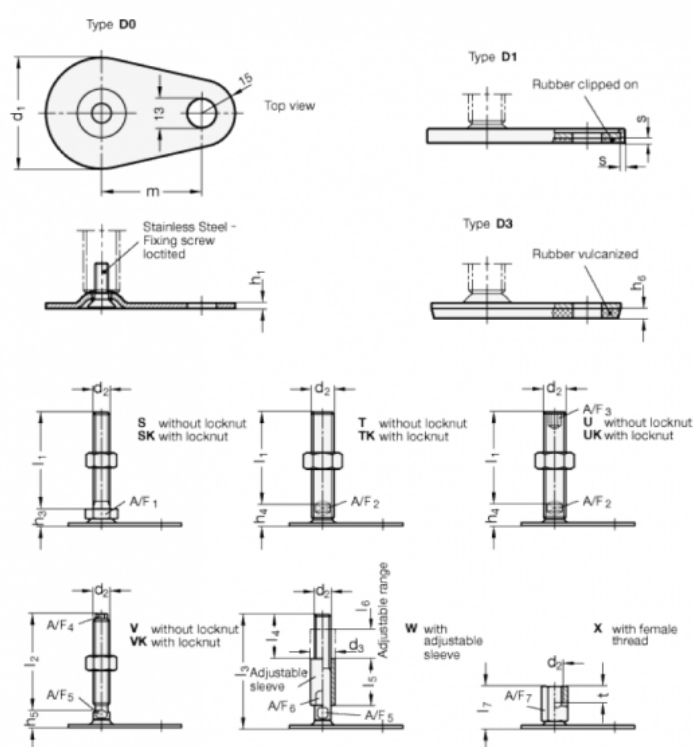

A/F1 = 17	s = 2
d1 = 60	
d2 = M8	
h1 = 2.5	
h3 = 11	
h6 =	
l1 = 63	
m = 50	